

METRIC FDA/USDA/3A Dairy Self-Lubricating Linear Bearings

**Food Process
Packaging Machinery
Bio/Pharmaceutical
Medical Systems**

RoHS
compliant



ETX Scraper Seals



Thin Wall Stainless/PTFE



European Stainless/PTFE



Fluidline



L.M76
Linear Bearings

The Engineering Edge

TWM Thin Wall Closed

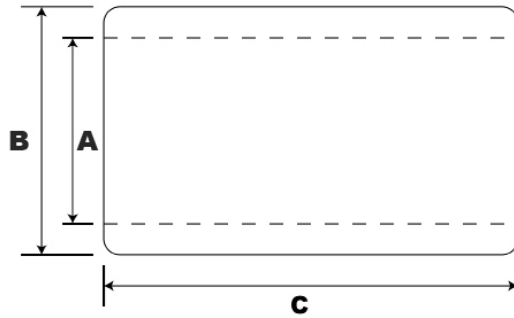

Rapid Oscillation	
Self-Lubricating	
Contamination	
FDA/USDA 3A Dairy/USPVVI Compliant	
Chemicals and Caustic Vapors	
Caustic Wash Down	
Shock & Vibration	

Max PSI	Max PV	Max Velocity (Meters per Minute) Lubricated	Max Velocity (Meters per Minute) Unlubricated	Max Operating Temp °F/°C	Minimum Operating Temp °F/°C	Static Coefficient of Friction	Dynamic Coefficient of Friction	Minimum Shaft Hardness
1000	10,000	122	31	+385/196	-400/204	.3	.09 - .15	Rb25

Bearing Shell Material	300 Stainless Steel
Self-Lube Liner	PTFE

ORDERING P/N EXAMPLE

L	6	TWM	SL	SS
---	---	-----	----	----

Part Number	Working Bore mm	Bore Tolerance	Outside Diameter mm	Length Tolerance h14	Max Shaft Diameter mm	Housing Bore Diameter mm	MAX STATIC LOAD
	A		B	C			N
L12TWMFDA	12	"	19	28	12	19	3160
L14TWMFDA	14	"	21	28	14	21	3986
L16TWMFDA	16	"	24	30	16	24	4715
L20TWMFDA	20	0,047-0,074	28	30	20	28	6990
L25TWMFDA	25		35	40	25	35	11250
L30TWMFDA	30		40	50	30	40	16340
L40TWMFDA	40	0,049-0,089	52	60	40	52	29410
L50TWMFDA	50		62	70	50	52	46126

All LM76 FDA Linear Bearings are compatible with soft 300 Series (303,304,316) Stainless Steel Shafting - Rb25. LM76 also supplies Armoloy® Coated Shafting for additional hardness and chemical resistance.

NOTE 1. LM76 European Metric linear bearings can be slip fit into a housing and retained with stainless snap rings or with a light pressfit. Press-fit should not exceed .0127mm.

NOTE 2. TWM-FDA Bearings are only supplied in closed version.

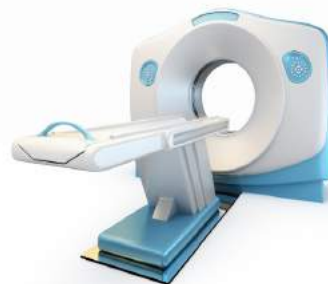

European Metric Closed

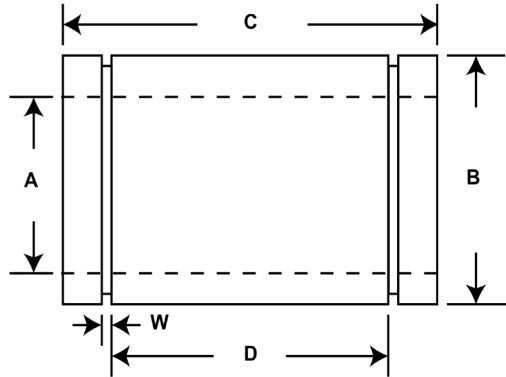

Max PSI	Max PV	Max Velocity (Meters per Minute) Lubricated	Max Velocity (Meters per Minute) Unlubricated	Max Operating Temp °F/°C	Minimum Operating Temp °F/°C	Static Coefficient of Friction	Dynamic Coefficient of Friction	Minimum Shaft Hardness
1000	10,000	122	31	+385/196	-400/204	.3	.09 - .15	Rb25

Bearing Shell Material	300 Stainless Steel
Self-Lube Liner	PTFE

ORDERING P/N EXAMPLE

L 6 FDA

Rapid Oscillation	
Self-Lubricating	
Contamination	
FDA/USDA 3A Dairy/USPVI Compliant	
Chemicals and Caustic Vapors	
Caustic Wash Down	
Shock & Vibration	

Part Number	Working Bore mm	Max Shaft Dia. h6 or h7 Tolerance	ID Bore Tolerance -.000	O.D. Diameter	Bearing Length h14 Tolerance	Retaining Ring	Retaining Groove Width	Housing Bore Diameter h7	MAX STATIC LOAD
	A			B		D	W		N
L12-FDA	12	12	0,038-0,065	22	32	D=20 W=1,3	1.32	22	3720
L16-FDA	16	16	0,038-0,065	26	36	D=22 W=1,6	1.32	26	5740
L20-FDA	20	20	0,047-0,089	32	45	D=28 W=1,6	1.63	32	8879
L25-FDA	25	25	0,047-0,089	40	58	D=40 W=1,85	1.90	40	14732
L30-FDA	30	30	0,047-0,089	47	68	D=48 W=1,85	1.90	47	20893
L40-FDA	40	40	0,049-0,089	62	80	D=56 W=2,15	2.20	62	31207
L50-FDA	30	50	0,049-0,089	75	100	D=72 W=2,65	2.70	75	49890

All LM76 FDA Linear Bearings are compatible with soft 300 Series (303,304,316) Stainless Steel Shafting - Rb25. LM76 also supplies Armoloy® Coated Shafting for additional hardness and chemical resistance.

NOTE 1. LM76 European Metric linear bearings can be slip fit into a housing and retained with stainless snap rings or with a light press-fit. Pressfit should not exceed .0127mm.

ETX SCRAPER SEALS



LM76 Stainless European Metric linear bearings can be modified with ETX scraper seals. ETX Seals are self-lubricating snap-in scraper seals which are FDA/USDA/3A Dairy/USPVI/Caustic Wash Down compliant. Because they are designed with an interference fit on the shaft, they do increase friction. ETX Scraper Seals are long wearing and will not allow debris to include between the bearing and the shaft. Excellent for cheese process, dairy, meat and poultry applications. To add ETX Seals, add 2ETX to the part number.

NOTE: ETX Scraper Seals are only available in closed style bearings.

Ordering Example: **L12TWMSLSS-2ETX**

European Metric Open

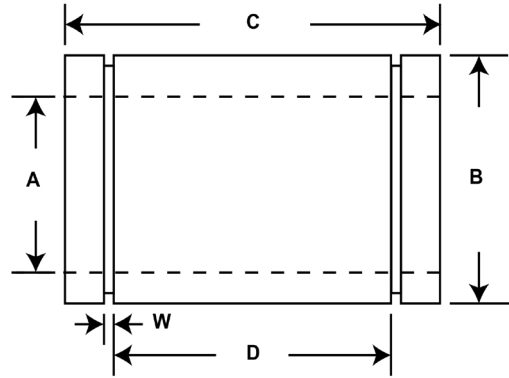

Max PSI	Max PV	Max Velocity (Meters per Minute) Lubricated	Max Velocity (Meters per Minute) Unlubricated	Max Operating Temp °F/°C	Minimum Operating Temp °F/°C	Static Coefficient of Friction	Dynamic Coefficient of Friction	Minimum Shaft Hardness
1000	10,000	121	31	+385/196	-400/204	.3	.09 - .15	Rb25

Bearing Shell Material	300 Stainless Steel
Self-Lube Liner	PTFE

Rapid Oscillation	
Self-Lubricating	
Contamination	
FDA/USDA 3A Dairy/USPVI Compliant	
Chemicals and Caustic Vapors	
Caustic Wash Down	
Shock & Vibration	

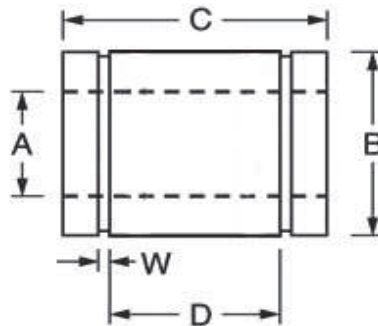
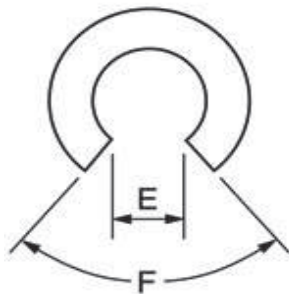

ORDERING P/N EXAMPLE

LX 6 FDA

Part Number	Working Bore mm	Max Shaft Dia. h6 or h7 Tolerance	ID Bore Tolerance -.000	O.D. Diameter	Bearing Length h14 Tolerance	Retaining Ring	Slot Width	Slot Angle	Housing Bore Diameter h7	MAX STATIC LOAD
	A				B					
LX12-FDA	12	12	0,038-0,065	22	32	D=20 W=1,3	7.6	60	22	3720
LX16-FDA	16	16	0,038-0,065	26	36	D=22 W=1,6	10.4	78	26	5740
LX20-FDA	20	20	0,047-0,089	32	45	D=28 W=1,6	10.8	78	32	8879
LX25-FDA	25	25	0,047-0,089	40	58	D=40 W=1,85	13.2	60	40	14732
LX30-FDA	30	30	0,047-0,089	47	68	D=48 W=1,85	14.2	72	47	20893
LX40-FDA	40	40	0,049-0,089	62	80	D=56 W=2,15	19.5	72	62	31207
LX50-FDA	30	50	0,049-0,089	75	100	D=72 W=2,65	24.0	72	75	49890

All LM76 FDA Linear Bearings are compatible with soft 300 Series (303,304,316) Stainless Steel Shafting - Rb25. LM76 also supplies Armoloy® Coated Shafting for additional hardness and chemical resistance.

NOTE 1. LM76 European Metric linear bearings can be slip-fit into a housing and retained with stainless snap rings or with a light press-fit. Pressfit should not exceed .0127mm.

FluidLine Metric Closed



FluidLine Linear Bearings offer a 1 piece construction that allows it to stay in service even after there is significant wear. Unlike our stainless bearings with a FDA compliant PTFE liner (.64mm - .89mm thick), once you wear through the PTFE liner, the bearing must be replaced because the shaft will be in contact with the stainless steel bearing shell. Because Fluidline is a one piece design, it can stay in service longer - it will reach a point where it is too slackened. Great for conveyor indexers and check-weight rejection thrusters. **NOTE:** Fluidline is a non-metallic linear bearing and thus it will dissipate heat more slowly. Not made for high speed, long travel applications. **Closed Bearings Only**

Max PSI	Max PV	Max Velocity (Meters per Minute) Lubricated	Max Velocity (Meters per Minute) Unlubricated	Max Operating Temp °F/°C	Minimum Operating Temp °F/°C	Static Coefficient of Friction	Dynamic Coefficient of Friction	Minimum Shaft Hardness
1000	10,000	121	30	+385/196	-400/204	.3	.09 - .15	Rb25

Bearing Material	PET-P
------------------	-------

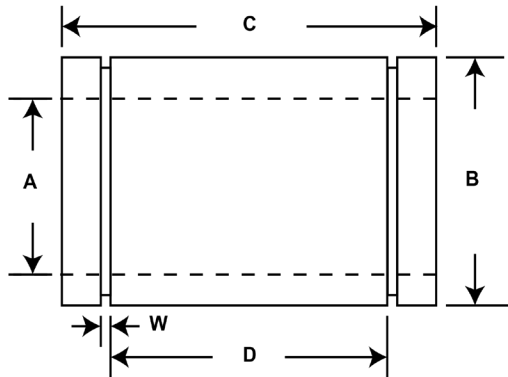

ORDERING P/N EXAMPLE

FDL	50
-----	----

Rapid Oscillation	
Self-Lubricating	
Contamination	
FDA/USDA 3A Dairy/USPVI Compliant	
Chemicals and Caustic Vapors	
Caustic Wash Down	
Shock & Vibration	

Part Number	Working Bore mm	Max Shaft Dia. h6 or h7 Tolerance	ID Bore Tolerance -.000	O.D. Diameter	Bearing Length h14 Tolerance	Retaining Ring	Slot Width	Slot Angle	Housing Bore Diameter h7	MAX STATIC LOAD
	A				C					
FDL-12	12	12	0,038-0,065	22	32	D=20 W=1,3	7.6	60	22	3720
FDL-16	16	16	0,038-0,065	26	36	D=22 W=1,6	10.4	78	26	5740
FDL-20	20	20	0,047-0,089	32	45	D=28 W=1,6	10.8	78	32	8879
FDL-25	25	25	0,047-0,089	40	58	D=40 W=1,85	13.2	60	40	14732
FDL-30	30	30	0,047-0,089	47	68	D=48 W=1,85	14.2	72	47	20893
FDL-40	40	40	0,049-0,089	62	80	D=56 W=2,15	19.5	72	62	31207
FDL-50	30	50	0,049-0,089	75	100	D=72 W=2,65	24.0	72	75	49890

Fluidline Linear Bearings are compatible with soft 300 Series (303,304,316) Stainless Steel Shafting - Rb25. LM76 also supplies Armoloy® Coated Shafting for additional hardness and chemical resistance.

NOTE 1. LM76 European Metric linear bearings can be slip-fit into a housing and retained with stainless snap rings or with a light press-fit. Pressfit should not exceed .0127mm.

NOTE 2. Fluidline Bearings are only supplied in closed version.

LM76 140 Industrial Drive East Longmeadow, Ma USA 01028
1-413-525-4166 Fax: 413-525-3735 www.LM76.com

FluidLine Engineering Data

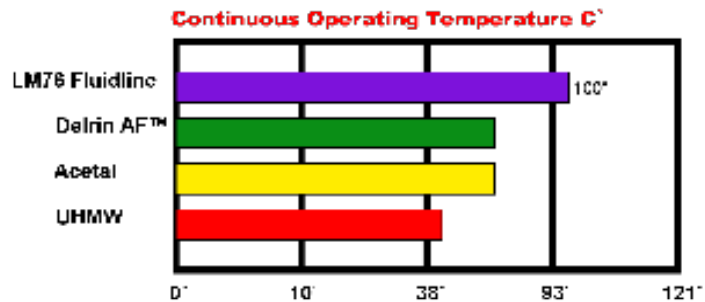
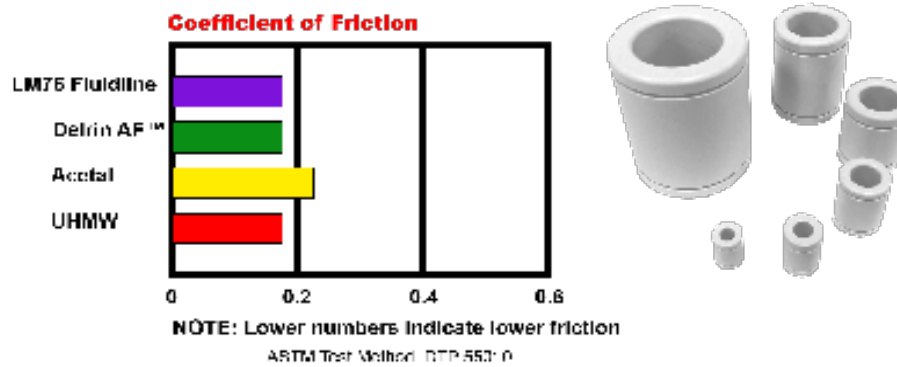
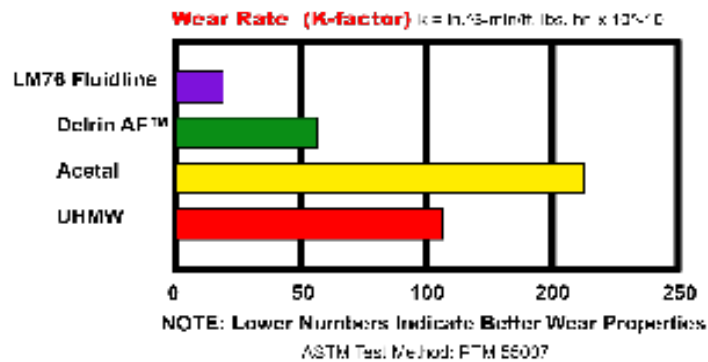

PTFE Bearing Engineering Data

Terms:

P = Pressure
 PSI = Pressure per square inch
 SFM = Surface Feet per Minute
 PV = Is the unit of measure determined by 2 values - Pressure (PSI) and Velocity (SFM)
 Formula: $P=W/(dxb)$ W = Static Load d = Bearing Inside Diameter b = Bearing Length

ID x Length = Total Number of Square mm of bearing liner material (PTFE) available to load

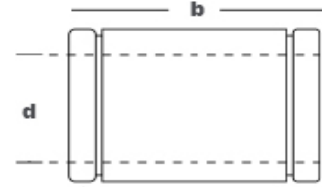

Example:

50kg (500) load on a 25mm ID bearing x 58mm Long
 $P=W/(dxb)$
 $P=500/(25x58) = 0.3448N/mm^2$ and the velocity is 0.25m/s
 $PV = 0.3448 x 0.25$
Result: $PV = 0.862N/mm^2$ m/s



Rule of Thumb: Plain Bearings, due to their increased contact area, are prone to "Sticktion" - the force or torque required to get them moving is higher than when they are in motion. We use a .3 multiplier i.e., 45kg will take 13.5 kg to get the system moving. Design your drives around this figure.

Understanding PV (Inverse Equation):

The total PV rating for our FDA/PTFE/Self-Lubricating liner is 10,000. PV works like this: If you go up on load, you go down in speed. If you go up on speed, you go down on load.



Rule of thumb: With a light load and lubrication, you can design around 121m/min system speed. Unlubricated, you can design around 30m/min system speed.

Over-Turning Moment Loads:

Plain bearings are more susceptible to moment loading than ball or roller systems in all three axis: pitch, yaw and roll.

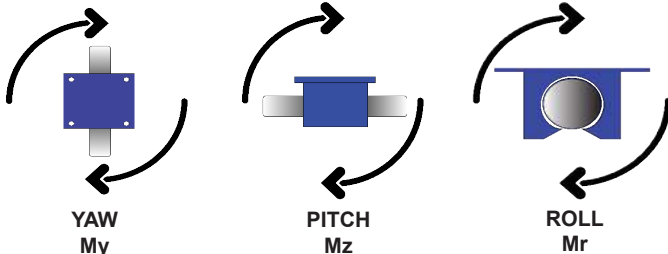

NOTE: Please contact LM76 Engineering for more information on moment loading.

OPEN Bearing Orientation Load Depreciator Max Static Load

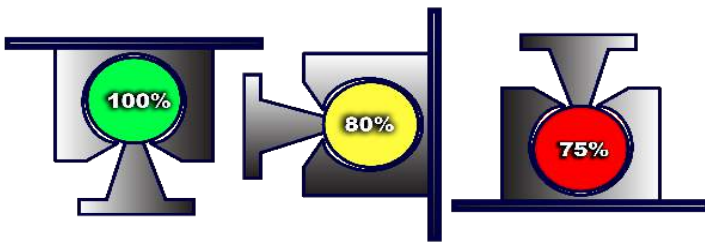

2:1 Ratio for Moment Loading

To specify bearing spacing relative to the c/g load point, we will use the following example for a vertical axis:

- Determine where the C/G (center of gravity) is located along the moment arm. For our example, we have illustrated (Figure 1.0) a liquid filling machine which has a c/g load point 305mm from the centerline of the shafting. Employing the 2:1 ratio - spacing between bearings must be a minimum of 1/2 the distance of the c/g load point on the moment arm - therefore, spacing between bearings must be a minimum of 153mm.



Rule of thumb: Use all the distance between bearings that is physically available up to a 1:1 ratio - more is always better.

Press-fit vs. Slip-Fit

LM76 linear bearings can be slip-fit into a housing and retained with stainless snap rings. They can also be press-fit with a light press - **DO NOT EXCEED .127mm**

Bearing Edge Loading:

Edge loading is a condition resulting from excessive moment loading, lack of parallelism between shafts or any situation where bearing and shaft centerlines are out of alignment. Edge loading results in higher friction and wear. Extreme cases will cause sticking & slipping and in severe situations, system seizure.

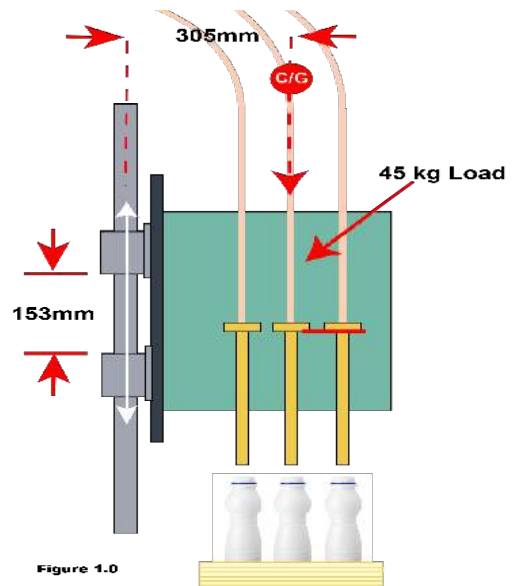
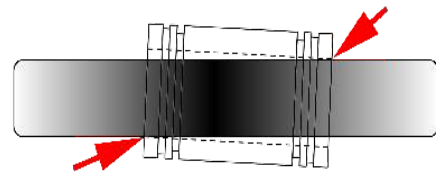

Figure 1.0

Standard Sanitation Procedures & LM76 Linear FDA Bearings/Shafting/Slides



Sanitation & Linear Motion Products

Food processing plant machinery is subject to high pressure wash down and harsh chemicals. Bakery and fruit products may only see warm water and detergents. However, meat, poultry and dairy products see aggressive chlorinated, caustic foaming agents and sodas like sodium hydroxide. These chemicals are extremely corrosive to bearings, shafting and slides. Bearings that are greased will experience grease evacuation because of high pressure washing and chemical contamination - leading to bearing failure.

At LM76, we understand the issues associated with FDA compliant materials, both direct food contact and outside-the-product-zone applications, high pressure wash down and caustic foaming agents.

LM76 Materials and Protective Coatings

LM76 employs stainless steel (300 Series Stainless) for our bearing shells and linear shafting. In addition, we use proven and compliant bonded PTFE liners that are highly inert and self-lubricating. LM76 also employs a number of proven and compliant coatings such as Ceramic Coated Aluminum and Electroless Nickel Plated Aluminum Pillow & Flange Blocks, Shaft Supports and Armoloy Coated Stainless Steel Shafting.

All that's FDA Compliant.
As compliance gets tougher, we get better.



Frozen Dinner Packaging Line

LM76 Has You Covered



1-800-513-3163

www.FDABEARINGS.com

LM76 was founded in 1976 and has been a proven, international designer/manufacturer of plain-style linear motion bearings. LM76 designed the original drop-in replacement for linear ball bearings in 1976 - our ceramic coated linear bearing. Our ceramic coated linear bearing has registered some of the highest accelerations seen by any product in our industry: +120G's along with fastest dynamic system speeds. To date, we have not found an excelleration or system speed where it has failed when properly employed. It has the longest life test of any linear bearing we are aware of:

PSI	ft/min	Final Distance	Wear
100	100	One Hundred Million Linear Feet	.00004"



**Ceramic Coated
European Metric**



**Ceramic Coated
Metric TWM Thin Wall**



**European Metric
Self-Lubricating**



**Metric Self-Lubricating
TWM Thin Wall**



LM76 is a prolific designer and manufacturer of special designs: ID's / OD's/ Lengths / Geometries made from a myriad of Materials. We design around your unique application, not a catalog product.

